

1-Line, Bi-directional, Transient Voltage Suppressor

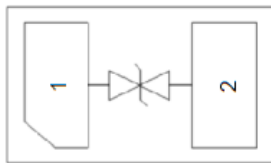

DFN1006-2L

Features

- Ultra small package
- Stand-off voltage: 5 V Max
- Transient protection for each line according to IEC61000-4-2(ESD): $\pm 30\text{kV}$ (contact)
IEC61000-4-5(surge): 26A (8/20 μs)
- Ultra-low capacitance: $C_J = 1.5\text{ pF typ}$
- Low leakage current
- Low clamping voltage
- RoHS Compliant

Applications

- Cellular Handsets and Accessories
- Display Ports
- MDDI / MHL
- USB 2.0
- Digital Visual Interface (DVI)
- PCI Express and Serial SATA Ports

Caution:

This Device is designed for signal line protection only.
Do not operate under electrical bias or connect to a power line.

Mechanical Characteristics

- Package: DFN1006-2L
- Case Material: "Green" Molding Compound.
- Marking Information: See Below

S7

S7= Device Marking Code

■ Definitions of electrical characteristics

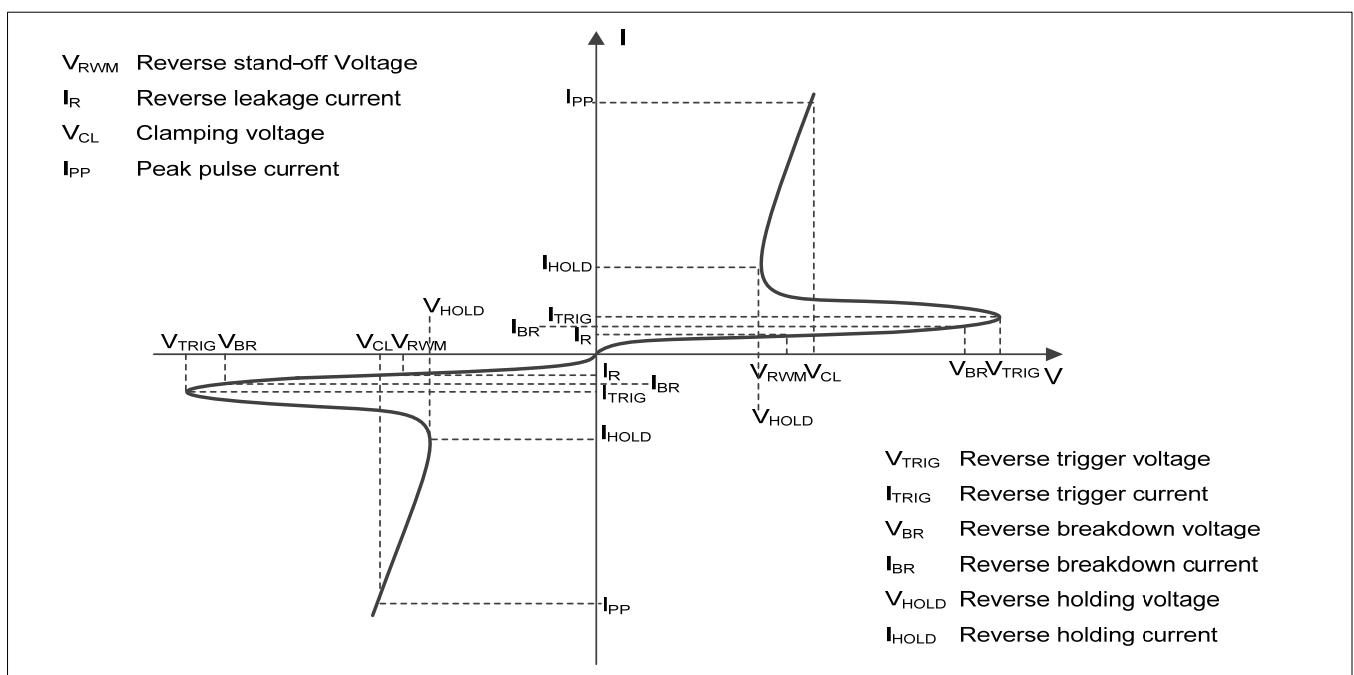



SESDSLC5V0LB1

■Absolute Maximum Ratings (Ta=25°C unless otherwise specified)

PARAMETER	SYMBOL	Rating	UNIT
Peak pulse power ($t_p = 8/20\mu s$)	P_{pk}	208	W
Peak pulse current ($t_p = 8/20\mu s$)	I_{PP}	26	A
ESD according to IEC61000-4-2 air discharge	V_{ESD}	± 30	KV
ESD according to IEC61000-4-2 contact discharge		± 30	KV
Junction temperature	T_J	-55~125	°C
Storage temperature	T_{STG}	-55~150	°C

■Electrical Characteristics (Ta=25°C Unless otherwise specified)

PARAMETER	Symbol	UNIT	Conditions	Min	Typ	Max
Reverse maximum working voltage	V_{RWM}	V				5
Reverse breakdown voltage	V_{BR}	V	$I_{BR} = 1mA$	6		
Reverse leakage current	I_R	μA	$V_{RWM} = 5V$			0.2
Clamping voltage ³⁾	V_{CL}	V	$I_{PP} = 26A, t_p = 8/20\mu s$			8
Junction capacitance	C_J	pF	$V_R = 0V, f = 1MHz$		1.5	

(1). TLP parameter: $Z_0 = 50\Omega, t_p = 100ns, t_r = 2ns$, averaging window from 60ns to 80ns. R_{DYN} is calculated from 4A to 16A.

(2). Contact discharge mode, according to IEC61000-4-2.

(3). Non-repetitive current pulse, according to IEC61000-4-5.

■Ordering Information (Example)

PREFERED P/N	UNIT WEIGHT(mg)	MINIMUM PACKAGE(pcs)	INNER BOX QUANTITY(pcs)	OUTER CARTON QUANTITY(pcs)	DELIVERY MODE
SESDSLC5V0LB1	Approximate 0.9	10000	40000	400000	Tae& reel



SESDSLC5V0LB1

■ Typical Performance Characteristics (Ta=25°C unless otherwise Specified)

Fig1, 8/20μs waveform per IEC61000-4-5

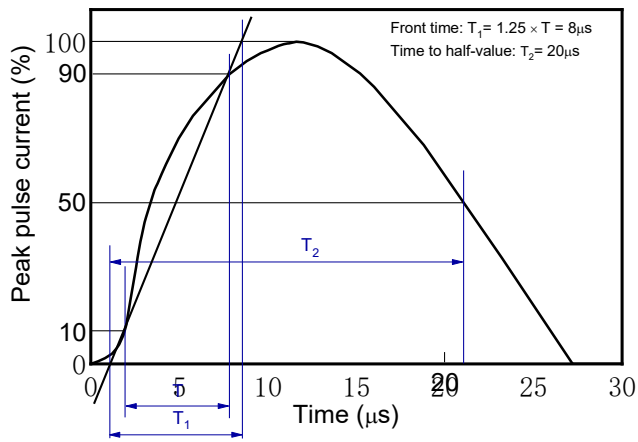

Fig2, Contact discharge current waveform per IEC61000-4-2

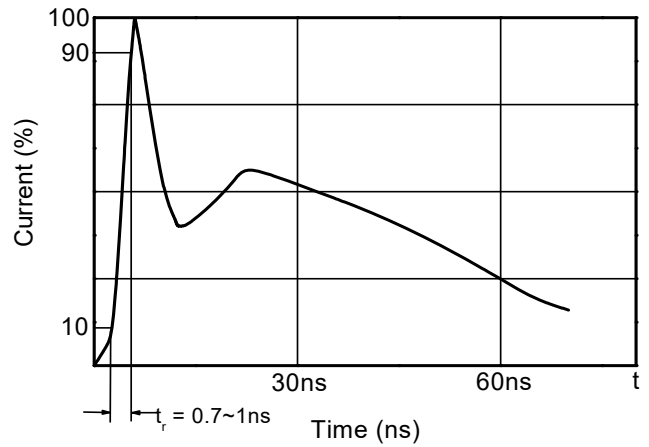

Fig3, Clamping voltage vs. Peak pulse current

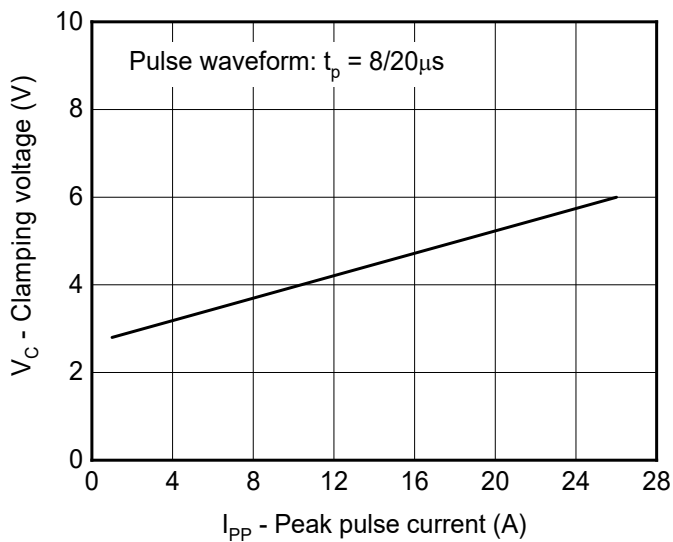

Fig4, Capacitance vs. Reverse voltage

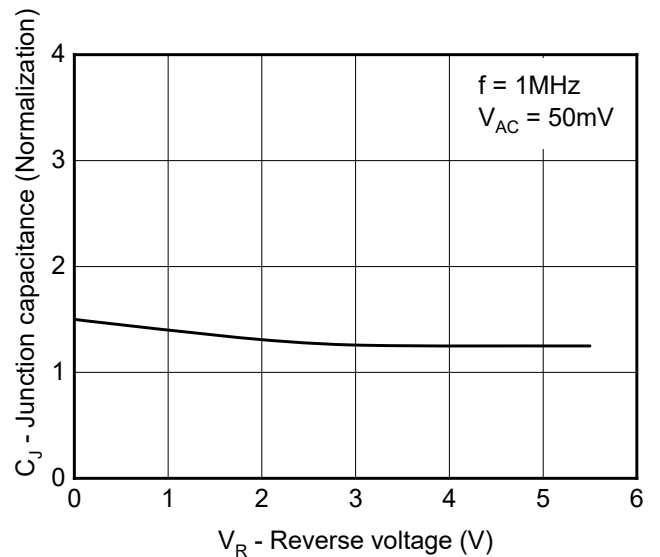

Fig5, Non-repetitive peak pulse power vs. Pulse time

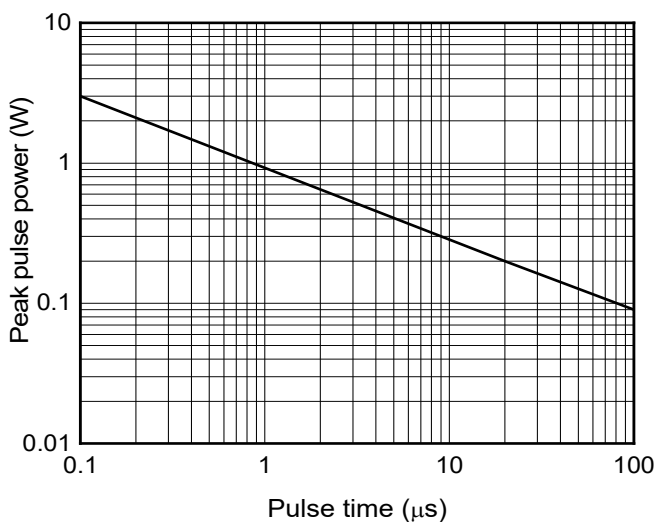

Fig6, Power derating vs. Ambient temperature

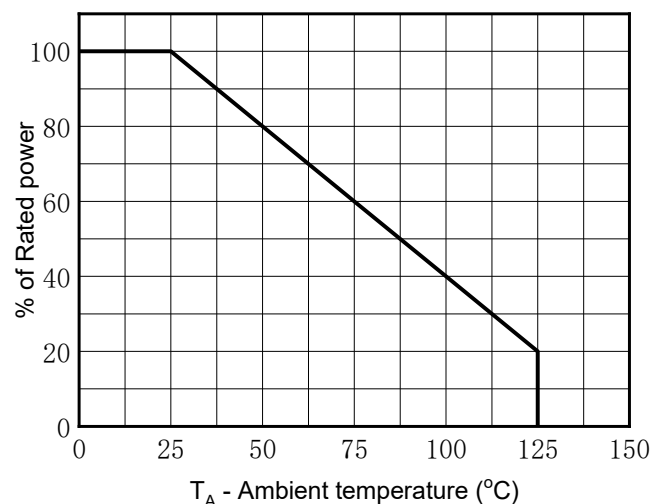
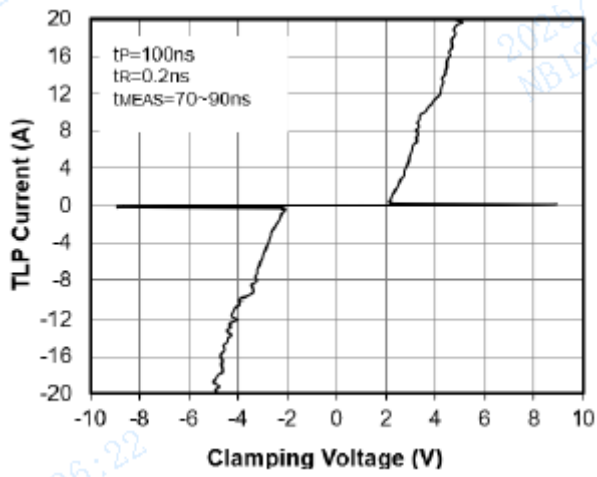



Fig5, TLP Measurement





SESDSLC5V0LB1

■ Outline Dimensions

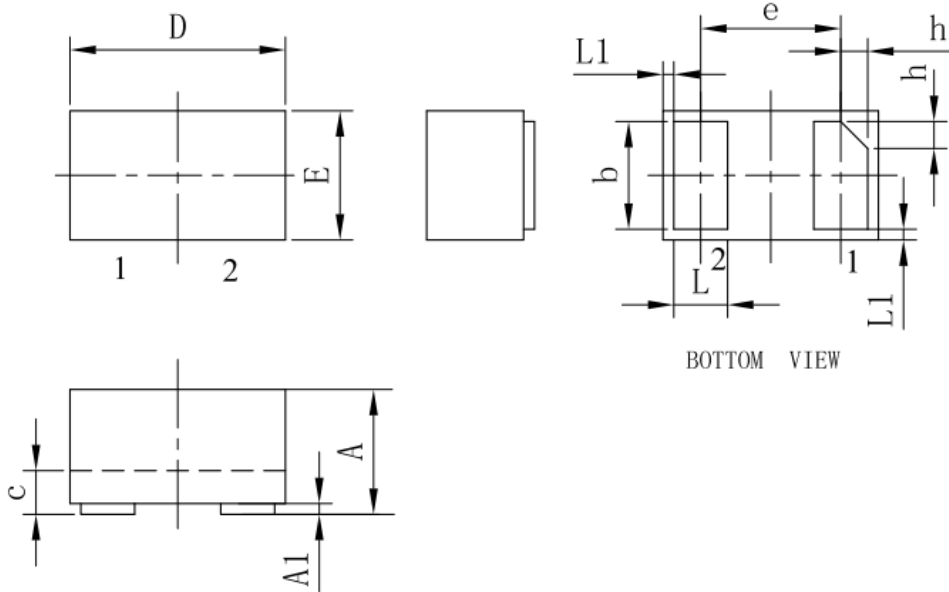

SYM	DIMENSIONS					
	MILLIMETERS			INCHES		
	MIN	NOM	MAX	MIN	NOM	MAX
A	0.45	0.50	0.55	0.018	0.020	0.022
A1	0.00	0.02	0.05	0.000	0.001	0.002
b	0.45	0.50	0.55	0.018	0.020	0.022
c	0.12	0.15	0.18	0.005	0.006	0.007
D	0.95	1.00	1.05	0.037	0.039	0.041
e	0.65 BSC			0.026 BSC		
E	0.55	0.60	0.65	0.022	0.024	0.026
L	0.20	0.25	0.30	0.008	0.010	0.012
L1	0.05REF			0.002REF		
h	0.07	0.12	0.17	0.003	0.005	0.007

■ Recommend land pattern (Unit:mm)

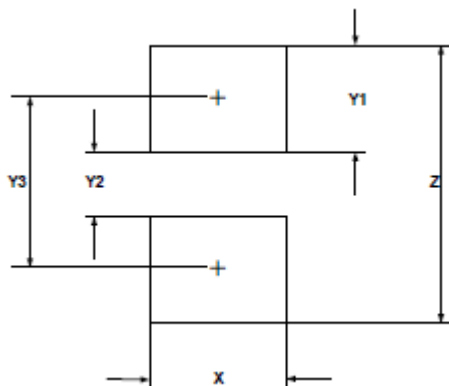

SYM	DIMENSIONS	
	MILLIMETERS	INCHES
X	0.60	0.024
Y1	0.50	0.020
Y2	0.30	0.012
Y3	0.80	0.032
Z	1.30	0.052

Notes:

This recommended land pattern is for reference purposes only. Please consult your manufacturing group to ensure your PCB design guidelines are met



SEDSL5C5V0LB1

Disclaimer

The information presented in this document is for reference only. Yangzhou Yangjie Electronic Technology Co., Ltd. reserves the right to make changes without notice for the specification of the products displayed herein to improve reliability, function or design or otherwise.

The product listed herein is designed to be used with ordinary electronic equipment or devices, and not designed to be used with equipment or devices which require high level of reliability and the malfunction of which would directly endanger human life (such as medical instruments, transportation equipment, aerospace machinery, nuclear-reactor controllers, fuel controllers and other safety devices), Yangjie or anyone on its behalf, assumes no responsibility or liability for any damages resulting from such improper use of sale.

This publication supersedes & replaces all information previously supplied. For additional information, please visit our website [http:// www.21yangjie.com](http://www.21yangjie.com) , or consult your nearest Yangjie's sales office for further assistance.