

1-Line, Uni-directional, Transient Voltage Suppressor

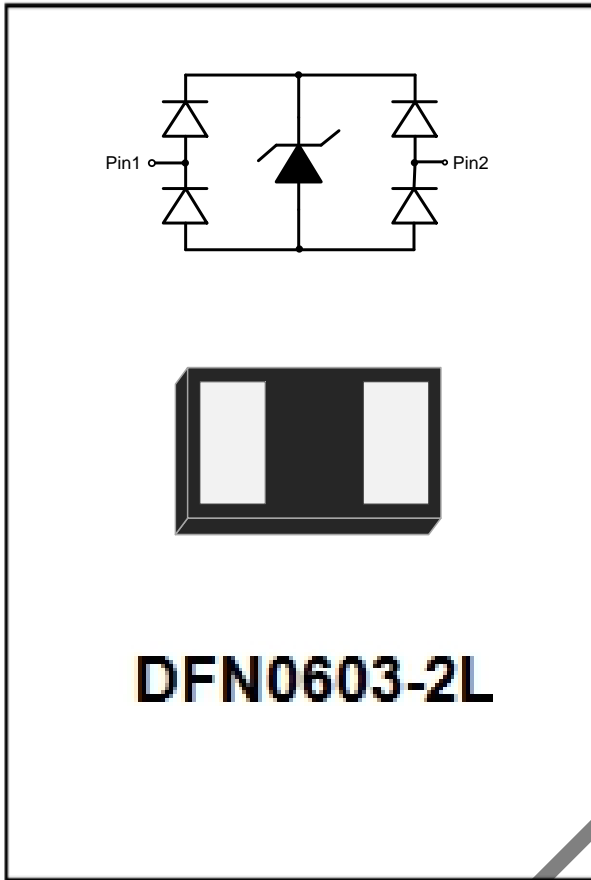

Features

- Ultra small package
- Stand-off voltage: 5V Max
- Transient protection for each line according to
 - IEC61000-4-2(ESD): $\pm 20\text{kV}$ (Air)
 - IEC61000-4-2(ESD): $\pm 20\text{kV}$ (contact)
 - IEC61000-4-5(surge): 2.5A (8/20 μs)
- Ultra-low capacitance: $C_J = 0.3\text{pF}$ typ
- Low leakage current
- Low clamping voltage
- RoHS Compliant

Applications

- Cellular Handsets and Accessories
- Display Ports
- MDDI Ports
- USB Ports
- Digital Visual Interface (DVI)
- PCI Express and Serial SATA Ports

Mechanical Characteristics

- Package: DFN0603-2L
- Case Material: "Green" Molding Compound.
- Marking Information: See Below



■Definitions of electrical characteristics

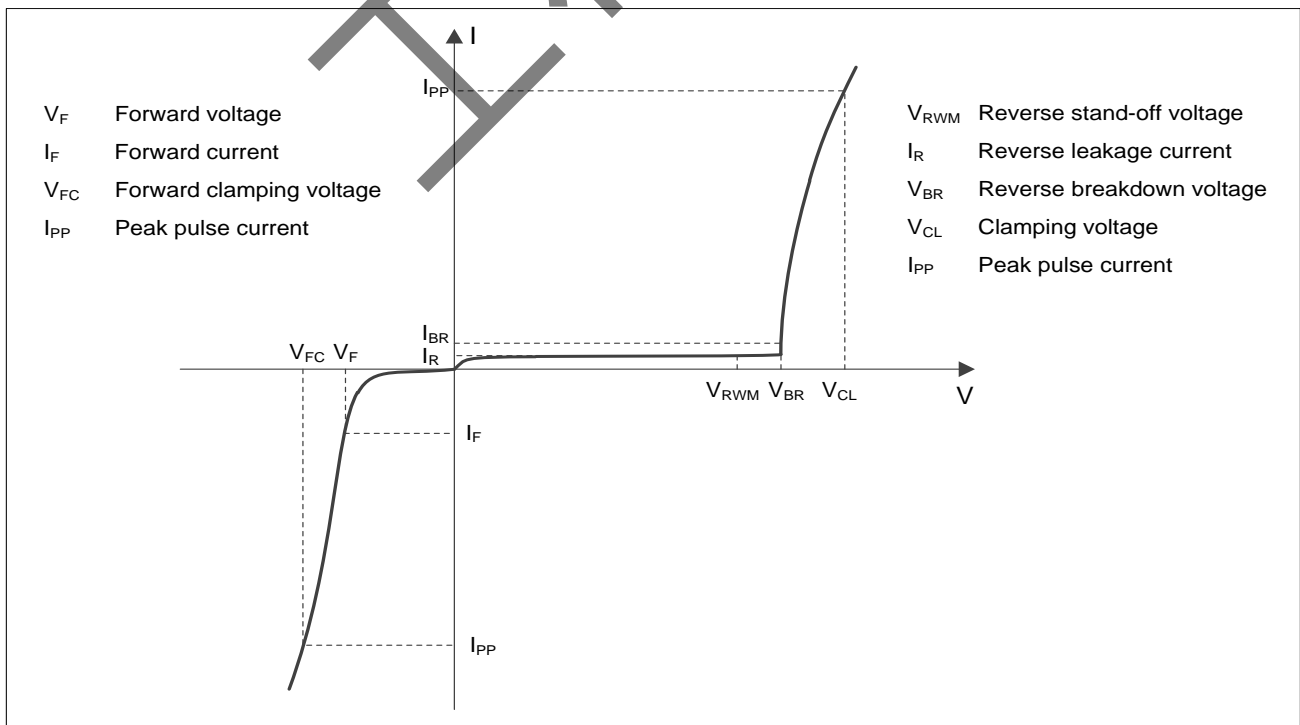



ESDSL5V0LZS

■Absolute Maximum Ratings (Ta=25°C unless otherwise specified)

PARAMETER	SYMBOL	Rating	UNIT
Peak pulse power ($t_p = 8/20\mu s$)	P_{pk}	27.5	W
Peak pulse current ($t_p = 8/20\mu s$)	I_{pp}	2.5	A
ESD according to IEC61000-4-2 air discharge	V_{ESD}	± 20	kV
ESD according to IEC61000-4-2 contact discharge		± 20	kV
Junction temperature	T_J	-55~125	°C
Storage temperature	T_{STG}	-55~150	°C

■Electrical Characteristics (Ta=25°C Unless otherwise specified)

PARAMETER	Symbol	UNIT	Conditions	Min	Typ	Max
Reverse maximum working voltage	V_{RWM}	V				5
Reverse leakage current	I_R	μA	$V_{RWM} = 5V$			0.5
Reverse breakdown voltage	V_{BR}	V	$I_{BR} = 1mA$	6		
Clamping voltage 1)	V_{CL}	V	$I_{PP} = 1A, t_p = 8/20\mu s$			9
		V	$I_{PP} = 2.5A, t_p = 8/20\mu s$			11
Junction capacitance	C_J	pF	$V_R = 0V, f = 1MHz$		0.3	0.5

(1). Non-repetitive current pulse, according to IEC61000-4-5.

■Ordering Information (Example)

PREFERRED P/N	UNIT WEIGHT(mg)	MINIMUM PACKAGE(pcs)	INNER BOX QUANTITY(pcs)	OUTER CARTON QUANTITY(pcs)	DELIVERY MODE
ESDSL5V0LZS	Approximate 0.18	10000	100000	400000	Tape&reel



ESDSLC5V0LZS

■ Typical Performance Characteristics (Ta=25°C unless otherwise Specified)

8/20μs waveform per IEC61000-4-5

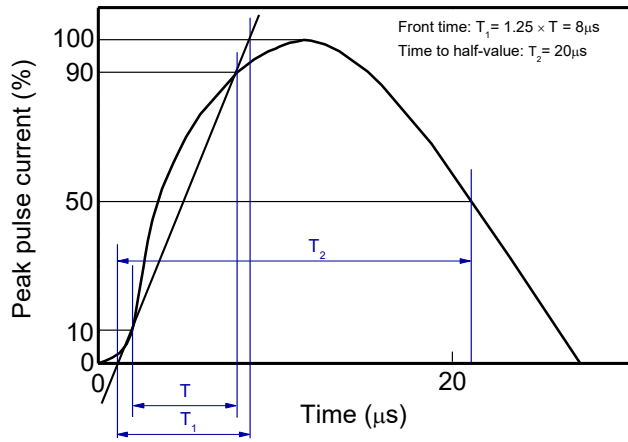

Contact discharge current waveform per IEC61000-4-2

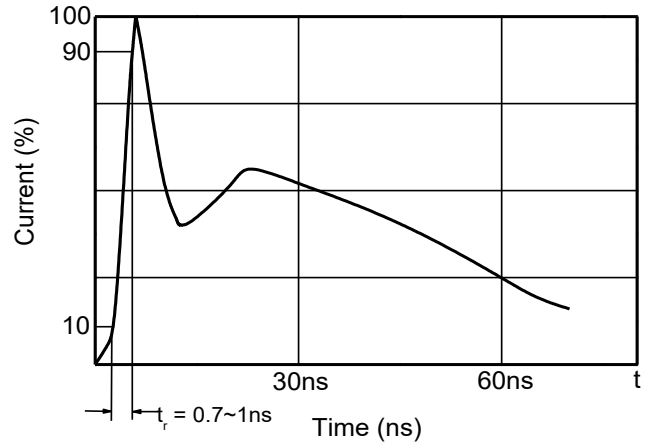

Clamping voltage vs. Peak pulse current

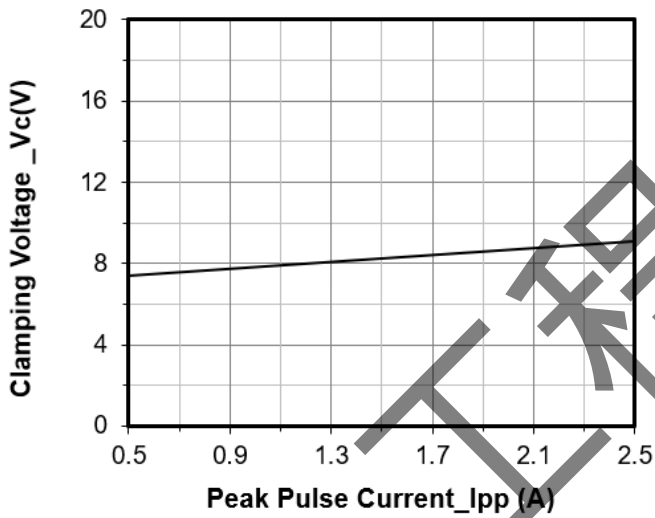

Capacitance vs. Reverse voltage

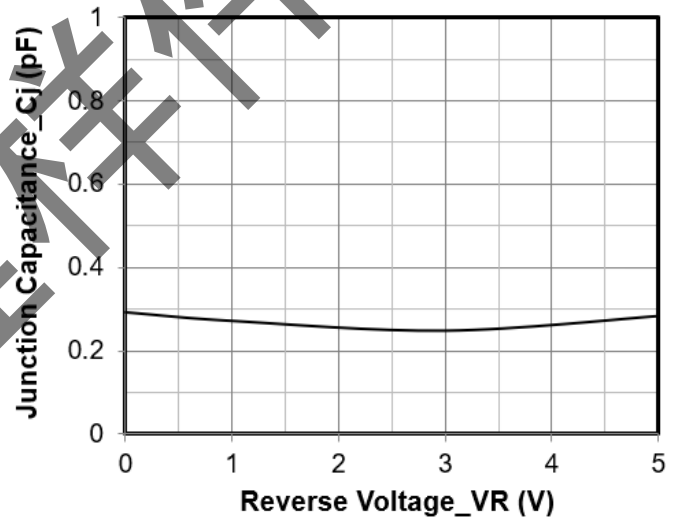

Non-repetitive peak pulse power vs. Pulse time

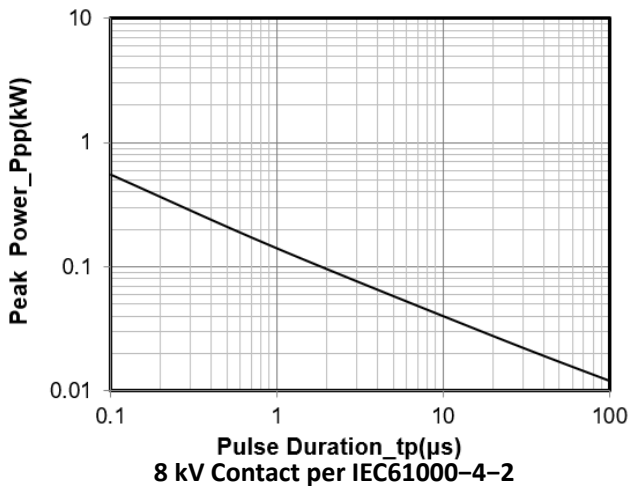

Power derating vs. Ambient temperature

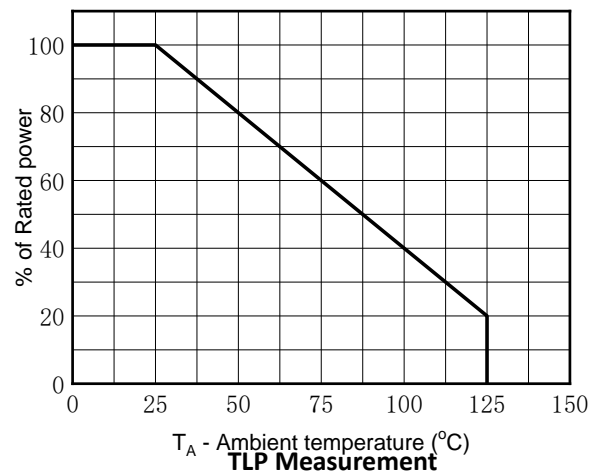



ESDSL5V0LZS

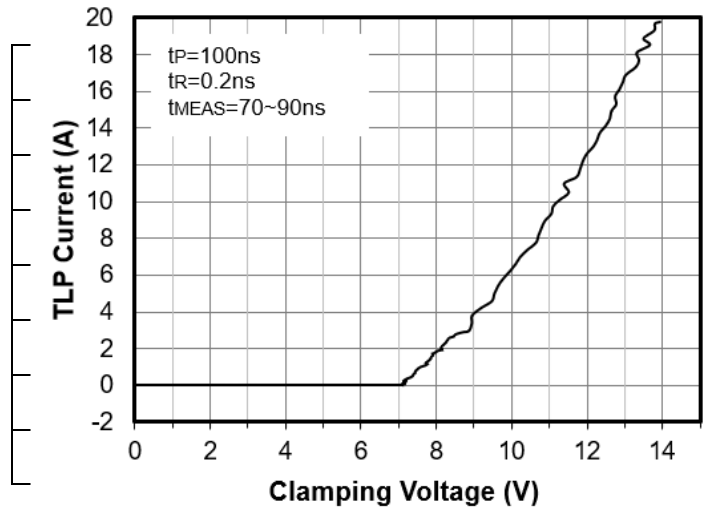
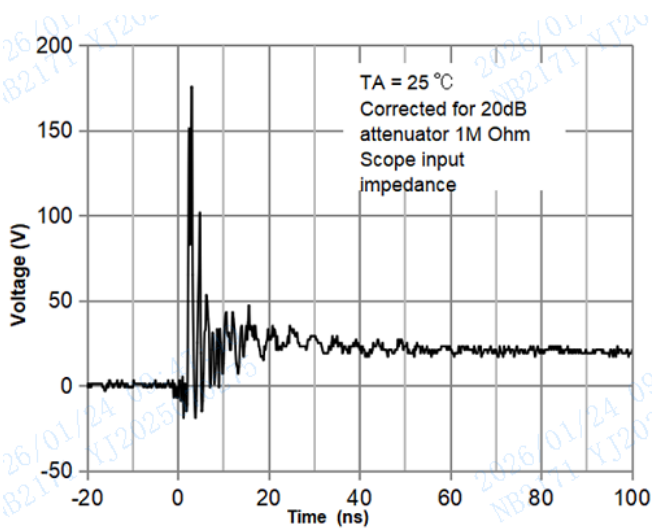

■ Outline Dimensions

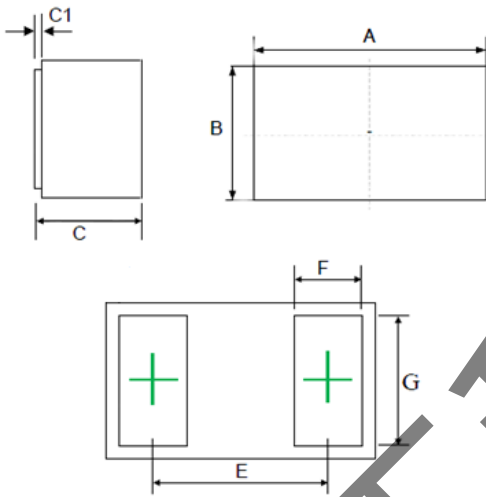

■ Recommend land pattern (Unit:mm)

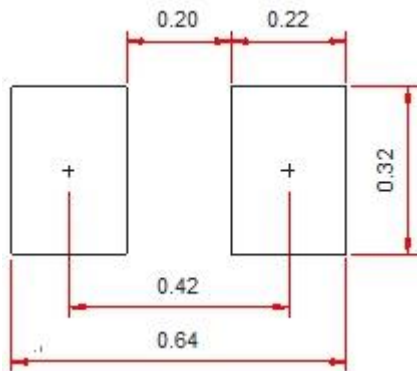

Notes:
This recommended land pattern is for reference purposes only. Please consult your manufacturing group to ensure your PCB design guidelines are met



ESDSL5V0LZS

Disclaimer

The information presented in this document is for reference only. Yangzhou Yangjie Electronic Technology Co., Ltd. reserves the right to make changes without notice for the specification of the products displayed herein to improve reliability, function or design or otherwise.

The product listed herein is designed to be used with ordinary electronic equipment or devices, and not designed to be used with equipment or devices which require high level of reliability and the malfunction of which would directly endanger human life (such as medical instruments, transportation equipment, aerospace machinery, nuclear-reactor controllers, fuel controllers and other safety devices), Yangjie or anyone on its behalf, assumes no responsibility or liability for any damages resulting from such improper use of sale.

This publication supersedes & replaces all information previously supplied. For additional information, please visit our website [http:// www.21yangjie.com](http://www.21yangjie.com) , or consult your nearest Yangjie's sales office for further assistance.

工程文件